



ALL IN ONE SOLAR STREET LIGHT

Technical Data Sheet

Integrated All in one

A compact lighting solution integrating Solar panels, LED light and Lithium battery with PIR motion sensor option.

WHY Green Tech

FREE CONSULTANCY SERVICE

- ☑ Luminaire technical evaluations
- 3D Simulations and Lighting Visualizations,
- Energy saving calculations

CUSTOMIZED MANUFACTURING

- Custom product designs and execution drawings
- Manufacture custom solutions in-line with any given brief

INSTALLATION SUPPORT

- Provide training, assistance and supervision
- Support testing and commissioning

Benefits

Lower Operation Cost: It is less expensive to operate a solar powered street light than a traditional street light.

Compact Design: Our design and technology implementation have been driven by our desire to eliminate the need for bulky external battery boxes and external solar panels and achieve All in One Solar Powered Street Light.

Reduced Damage/Theft: By locating directly on the light fixture and placing the battery within, the risk of damage, theft or tampering is greatly reduced. There are no wires in the street pole, which means that the wire itself (which exists in regular street lights) can't be stolen and sold for scrap.

Ruggedized Technology: Require less maintenance and reduced parts replacement due to initially incorporating higher quality components.

Insect Swarms: The solar powered street light uses LED lighting which does not produce Infrared light, and therefore will not attract insects.

Improved Safety: The solar powered street light does not require connection to an electrical grid. It is safer and easier to install. In the event of a power outage, the light remains on. This reduces the chance of accidents and the constant light deters theft/vandalism.

Anywhere/anytime: The solar powered street light can be used in any location. Since no electrical grid is required, it can be installed on buildings, in parking lots, in remote locations simply by hanging it on a pole.

Faster Installation: Since you don't need to trench power lines to the pole, run wires up the pole, connect wires to an electrical grid, or hard wire the street light, the installation is significantly faster. In fact, it is so easy, it can be installed on the pole before it's erected, and thereby reducing a step completely from the process.



LED MODULES

Exquisite design with powerful thermal output, with more reliable waterproof performance.



The new integrated solar streetlight from GreenTech will guarantee an efficiency up to 180Lm / W. In addition, it has great stability, and long life.



LM79

LM80

IP66

IK08

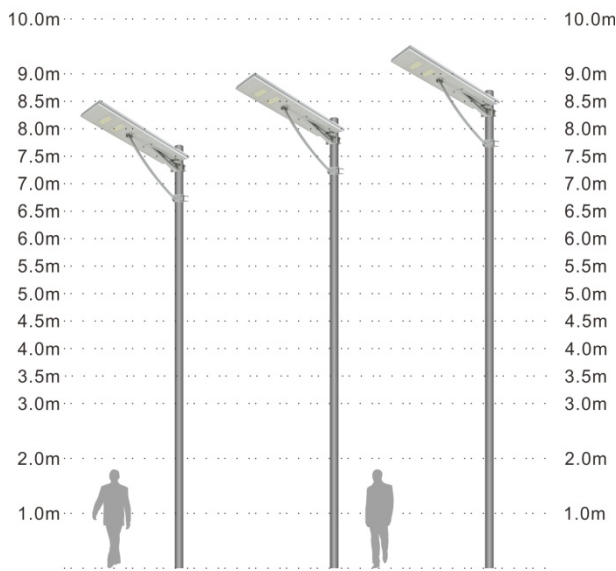

Recommended Installation Height

SYSTEM DATA

Colors	Aluminum/silver (natural finish), black, bronze. Custom RAL colors available upon request.
Material	Grade A corrosion resistant aluminum for panel mounts and battery enclosure. Steel and aluminum poles available.
Security	Batteries integrated under the solar panel reduce theft.
Backup	3-5 days
Pole	8-9m base on requirement
Lighting Time	8-12 hours/Night

FIXTURES

LED	60W, Bridgelux High Output Series
Light Distribution	Type II, Type III, Type IV
Color Temperature	3000K- 6500K
Efficacy Range	170 lumens per watt from complete fixture (6000K, via LM-79 testing)
Color Rendering Index	Minimum of 70 CRI
Mounting	Pole installation and Wall Installation

PHOTOVOLTAICS

Module	Monocrystalline silicon cells
Rated Max. Power at STC (Pm)	90Wp
Open Circuit Voltage (Voc)	22.5V
Max. Power Voltage (Vmp)	18V
Short Circuit Current (Isc)	5.57A
Max. Power current (Imp)	5.0A
Module Efficiency	>17.8%

BATTERY

Type	42Ah/12.8V, Deep Cycle Lithium Battery
Life cycle	>2000 times
Self-discharge Rate	< 3% Monthly
Operation Tem.	Working: -20 to +65°C; Storage: 0 to +45°C

CONTROLLER

Monitoring	APP remote monitoring option
Charging Type	MPPT
LED driver	high-efficiency driver integrated in the controller
Operating Profile Options	Dusk-to-dawn 100% power, various dimmed profiles
Day/Night Transition	Via solar panels

Photometric performance depends on the solar environment of location and specified operating profile. Contact a GreenTech representative for exact lumen output and specifications for your application

GTL-SSL-60W

Integrated Solar LED Lighting



Lamp Size Chart

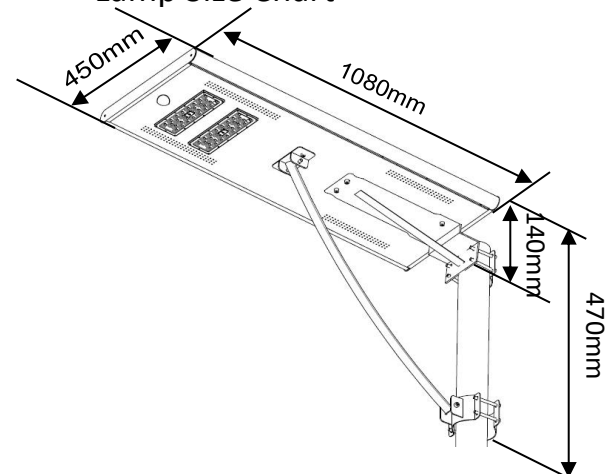

Illumination management

3- 5 rainy /cloudy days backup

Dusk-to-Dawn 12 hours with dim energy saving mode

Lighting times can be individually adjusted with program switch.

Illuminance in operation depending on local site conditions (average daylight available) and customer-specific lighting times.

Compact Design

No need wire connection, no need trenching, save installation time.

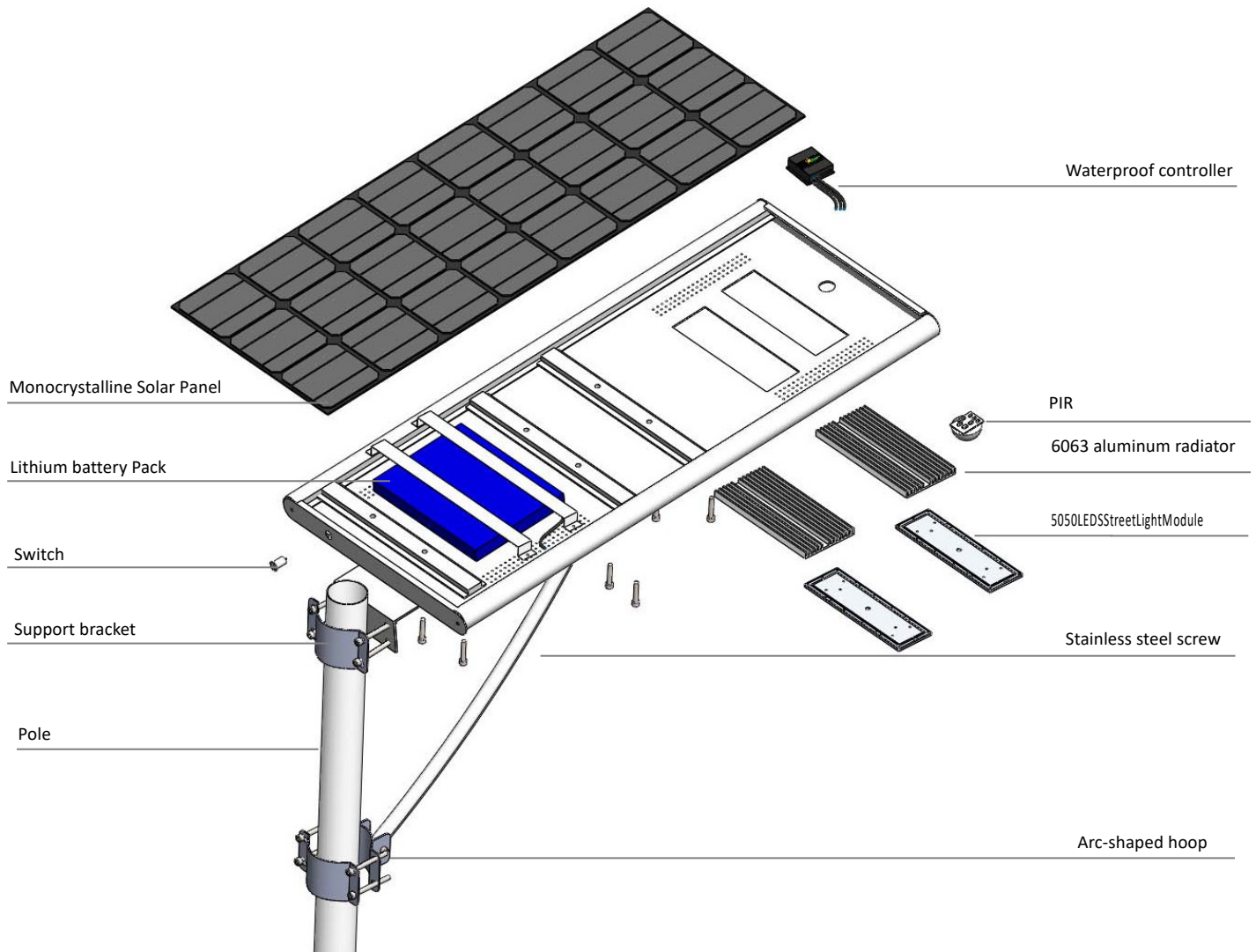

LIGHTING THE WAY

Built specifically to illuminate a wide range of applications, is the world's most versatile and compact LED solar lighting system. Its clever design and slim line construction incorporates the latest solar power, and LED technology, providing many years of consistent, performance and operational reliability.

BUILT TO LAST

Has been designed to withstand the harshest and most extreme environments has to offer; From blistering heat to driving rain, hail and sub-zero temperatures. Whatever the environment is, GreenTech rugged. Construction is up for the challenge. Its internal components offer IP65 weather protection and its external components are built with marine grade aluminium and stainless steel fixings

UNIQUE PROPERTIES

All-In-One solar module =Easy Installation Plug & Play wiring=Fast installation
Lithium battery technology offers up to 4 times more discharge capacity over Lead Acid types and 3 times more cycle life
Tamper and Theft proof design
Automated LED output options for greater battery autonomy
Customer replacement components

Motion Sensor (Option)

Built-in passive infrared motion sensor that automatically regulates the LED light output from full brightness to a lower level depending upon the detection of movement around the light.



All in one series has a built-in motion detection security feature that automatically regulates the LED light output from full brightness to a lower level depending upon the detection of movement around the light.

This fluctuation of lighting intensity preserves battery power and also serves to increase community security by deterring unsociable activity late at night and early in the morning where these lights are installed.

PIR Detection Area

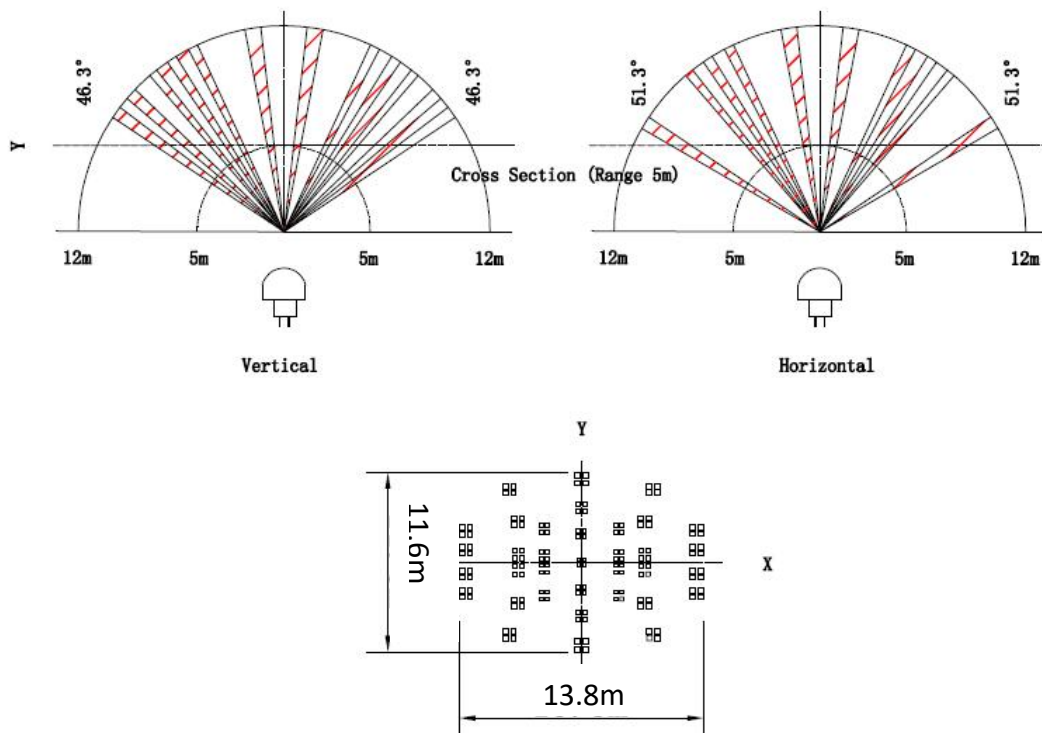

Multiple Light Distribution Options

GreenTech Street lights fit with a wide range of applications: highway, roadway, avenue, walking path or parking lot

GreenTech follows the North American IESNA standard in providing the optional lens width Type I, Type II and Type III. Type I is suitable for walking path with 1 lane, Type II is for 2 lanes and Type III is for even more wider road. GreenTech selects the most suitable lens for its customers according to the detailed parameters project by project.

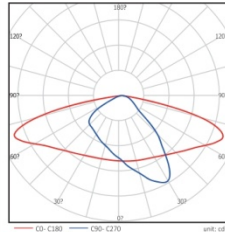
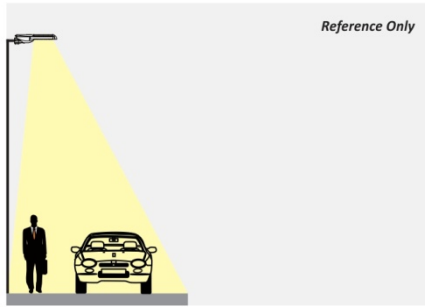

TYPE I

The Type I lens of have beam angle of 50*160 degrees.

In the IESNA Standard, The Type I distribution is great for lighting walkways, paths and sidewalks. It is generally applicable to where the mounting height is approximately equal to the roadway width.

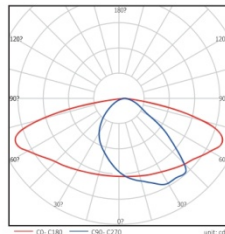
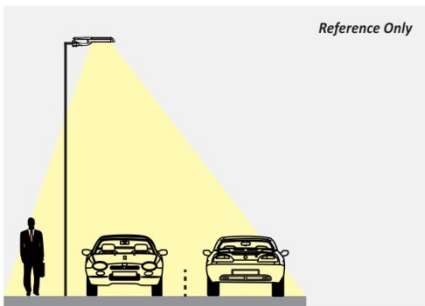

TYPE II

The Type II lens have beam angle of 65*155 degrees.

In the IESNA Standard, the Type II distribution is used for wide walkways, on ramps and entrance roadways, as well as other long, narrow lighting. It is generally applicable to where the width of the roadway does not exceed 1.75 times the designed mounting height.

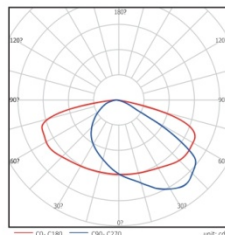
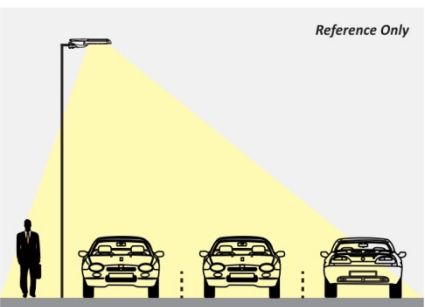

TYPE III

The Type III lens have beam angle of 80*160 degrees.

In the IESNA Standard, the Type III distribution is meant for roadway lighting, general parking areas and other areas where a larger area of lighting is required.

This distribution is intended for luminaires mounted at or near the side of medium width roadways or areas, where the width of the roadway or area does not exceed 2.75 times the mounting height.

Cloud-based Remote Monitoring System (Option)

Flexible light on/off, dimming profiles, motion detection that can be done from the cloud allows changes to the lights as needed without a site visit.



Smart Solar Street Light Remote Management System 4G+Zigbee Network

- REMOTELY CONTROL THE SWITCH AND LIGHTING ADJUSTMENT**
Control and configure The lights remotely from Any where based on your Seasonal requirement.
- CLOUD OPERATION MONITORING**
Manage the voltage, power, energy consumption or any failures anywhere, everywhere all through the cloud management system.
- FREE SWITCH ON WORKING MODE**
Remote free switch on the working mode to save energy consumption and prolong working time Of the light according to specific project requirements.
- BIG DATA ANALYSIS**
Remote monitoring information, real time inquiries and historical Data inquiries, can be generated to a statement or graphical representation for easy data analysis.
- FAILURE WARNING**
Immediate warning and alarm system to the client if any detection of malfunctions occurs.
- AUTHORITY MANAGEMENT**
Unified login password through system permission settings prevents unauthorized person to operate and keeps the system safer and reliable.

Shenzhen Green Tech Lighting Co., Ltd provides a total solution for intelligence street lighting system.

Green Tech street light intelligence system is made up by software, concentrator, terminal controller. The concentrator controller is installed in the distribution cabinet, the terminal controller is installed in the lighting terminal. It proceeds with communication via GPRS/CDMA/WCDMA wireless network or cable network & monitor center and proceeds with communication via ZIGBEE/PLC.

Concentrator controller can control each terminal controller via receiving, executing, forwarding PC management software , which can control each lamp's switching on /off or dimming ,then save electric energy. It can also monitor the lamps' electric energy to achieve failure lamps function. Concentrator controller can built-in DO to achieve street light loop control, it can connect with other equipment to collect local illumination, temperature and other information, feedback to PC management software and achieve to monitor the current information.

Easy Installation

Completion in approximately 1 hour each unit. This minimizes downtime which saves you money.

Make the solar panel face south while installing. Meanwhile, you can adjust the angel between the lamp head and level (as follow), you'd better reconcile the lamp head with local latitude.

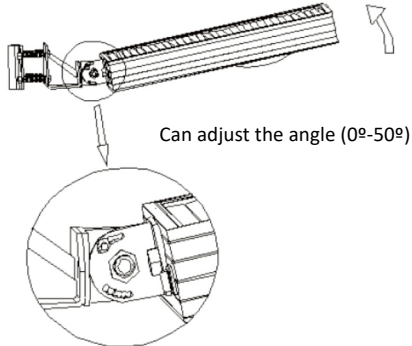

The second installation method, as followed:

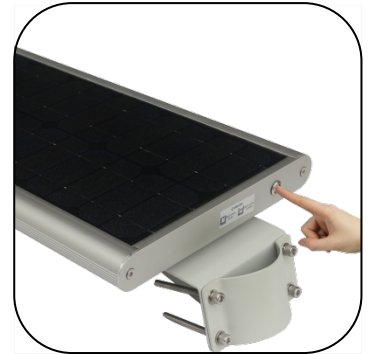
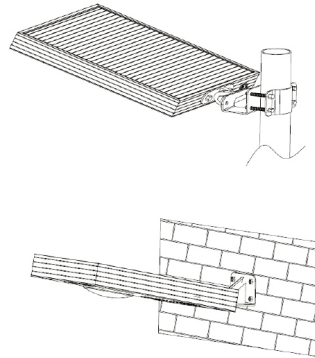

(All in one)
Solar Street light

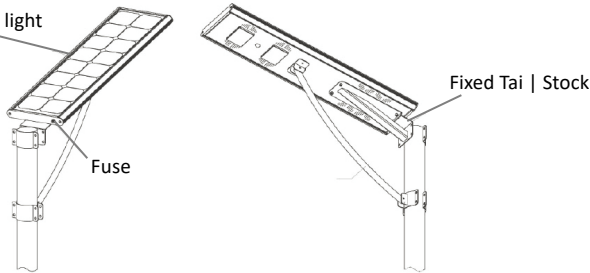

Installation notes (instructions are supplied with each unit)

- Install fuse if present before use (remove any film under fuse)
- Tool supplied to tighten security bolts provided
- Face solar panel as much towards the north as possible to maximize sun exposure (and therefore battery charge)

NB: As with all solar products, performance is wholly depended upon the hours of direct sunlight and the orientation of the solar panel.

Applications:

- Car parks, paths and laneways
- Private roads, gates and entrances

Safety and security:

- Playgrounds, courtyards
- Entrances, exits and muster areas
- Outside storage areas, perimeter lighting remote areas
- Where wiring is not economical or practical

Your SolarStreet Light Partner:

The specifications made herein may deviate slightly and are not guaranteed. Due to ongoing innovation, research and product enhancement we reserve the right to make any adjustments to the information contained herein at any time without notice. Please always obtain the most recent revision of datasheet which shall be duly incorporated into the binding contract made by the parties governing all transactions related to the purchase and sale of the products described herein.

Shenzhen Green Tech Lighting Co., Ltd

4th Floor, Building A, Maohui Industrial Zone, Yihui 3rd Road, Henglan Town, Zhongshan, Guangdong, China
sales@chinastreetlight.com +86- 18098902696